



# Truma VarioHeat<sup>®</sup> eco AU

**AUS** **Operating instructions**  
To be kept in the vehicle!

Page 2

## Inhaltsverzeichnis

Trademark information .....	2
Symbols used .....	2
Intended use .....	2
Prohibited use .....	2
<b>Safety instructions</b> .....	2
Function description .....	5

## Operating instructions

Start-up .....	5
<b>Room temperature sensor</b> .....	5
<b>Digital control panel Truma CP plus VarioHeat</b> .....	5
Intended use .....	5
<b>Safety instructions</b> .....	6
<b>Important information</b> .....	6
<b>Display and operating elements</b> .....	6
Rotary push button .....	6
Back button .....	6
<b>Initial start-up</b> .....	6
<b>Start-up</b> .....	6
<b>Functions</b> .....	7
Switching on and off .....	7
Changing the room temperature .....	7
Selecting the fan speed .....	7
Adjusting the time switch .....	8
Switching the lighting on and off .....	9
Setting the time .....	9
<b>Service menu</b> .....	9
<b>Special displays</b> .....	10
Power supply 230 V / 240 V ~ available .....	10
Infrared (IR) remote control (air conditioning system) .....	10
External control panel (CI-BUS) .....	10
Energy type display .....	10
<b>Warning</b> .....	10
<b>Error</b> .....	10
<b>Display specifications</b> .....	11
Maintenance of the Display .....	11
<b>VarioHeat fuses</b> .....	11
<b>Disposal of the VarioHeat</b> .....	11
Maintenance of the VarioHeat .....	11
<b>Heater specifications</b> .....	11
<b>Truma warranty policy</b> .....	12
<b>Troubleshooting guide for Truma VarioHeat</b> .....	13
<b>Troubleshooting guide (air conditioning system)</b> .....	13

## Trademark information

Truma VarioHeat® eco AU referred to as VarioHeat below.

## Symbols used



**The appliance must only be installed and repaired by an expert.**



Symbol indicates a possible hazard.



Comment including information and tips.

## Intended use

The VarioHeat liquefied gas heater is a warm-air heater for installation in recreational vehicles (RVs) only.

RVs are recreational vehicles designed as temporary living quarters for recreation, camping or travel use. Such vehicles have their own power or are towed by another vehicle.

## Prohibited use

Any use other than the intended use (see above) is prohibited. Examples of prohibited use:

- Use in a marine environment.
- Use as part of a space heating system.
- Use in mobile homes.
- Use in food trucks or roadside food vending vehicles.
- Use in construction trailers
- Use as a pool heater

## Safety instructions

– **Do not** operate this appliance before reading the instruction booklet.

– **Do not** place articles on or against this appliance.

– **Do not** spray aerosols in the vicinity of this appliance while it is in operation.

– **Do not** modify this appliance.

– **Do not** use or store chemicals, flammable materials or spray aerosols near the appliance.

## What to do if you smell gas.

- Extinguish all open flames
- Open doors and windows
- Close all quick-acting valves and gas cylinders
- Do not smoke
- Do not activate any electrical switches
- Have the complete gas system tested professionally.

## Safe operating environment

- Operate the appliance only with the corresponding control panels and accessories from Truma.

### – Risk of poisoning from exhaust gases

The exhaust gases from the heater can cause poisoning in enclosed spaces, such as garages or repair shops. If the RV is parked in an enclosed space:

- Block the fuel feed to the heater.
- Disable the time switch.
- Switch the heater off on the control panel.
- Make sure that appliances cannot be switched on via the Truma App.
- If the cowl was placed near or below a window that opens, the appliance must have an automatic switch-off device to prevent operation when the window is open.
- Keep flammable materials away from the area in front of warm air outlets. Never block the warm air outlets.
- So that the appliance does not overheat, do not obstruct the openings for circulated air intake, the opening to the installation location or the space around the appliance.
- The cowl for the exhaust duct and combustion air intake must be free of contamination at all times (slush, ice, leaves, etc.).
- Danger from hot surfaces and exhaust gas  
Do not touch the area around the wall cowl and do not lean any objects against the wall cowl or the vehicle.
- Air from the discharge vent may be hot. Do not place combustible materials directly in front of the discharge vent. Keep curtains, bedding and other flammable materials away from the vent.

### Obligations of the operator / vehicle owner

- The vehicle owner is responsible for correct operation of the appliance.
- The installer or vehicle owner must attach the yellow sticker with the warning that is supplied at a place in the vehicle that is visible for every user (e.g. on the wardrobe door). More stickers can be obtained from Truma.

– The vehicle owner must arrange for the gas system to be tested (in Germany every 2 years) by an LPG expert (in Germany DVFG, TÜV, DEKRA). This must be confirmed on the corresponding test certificate (G 607).

- Check hoses regularly and replace when they are brittle.
- Pressure control devices and hoses must be replaced at the latest after 10 years from the date of manufacture (8 years for commercial use).

### Safe operation

- To operate gas pressure regulation systems, gas appliances and gas systems, standing gas cylinders from which gas is **withdrawn from the gas phase** must be used. Gas cylinders from which gas is withdrawn from the liquid phase (e.g. for forklifts) are not permitted, as they damage the gas system.
- The working pressure of the gas supply (2.75 kPa) and of the appliance (see type plate) must correspond.
- LPG systems must comply with the technical and administrative regulations of the country in which they are used (in Europe, for example, EN 1949 for vehicles). National rules and regulations (in Germany, for example DVGW worksheet G 607 for vehicles) must be observed.
- For vehicles, we recommend the Truma MonoControl CS gas pressure regulation system and for two-cylinder systems, the Truma DuoComfort / DuoControl CS gas pressure regulation systems.
- At temperatures of 0 °C and below, the gas pressure regulation system and the change-over valve should be operated with the EisEx controller heater.
- Use only hoses that comply with the regulations of the country in which the appliance will be used.
- Ensure that the inside of the vehicle is sufficiently ventilated. When you start up the appliance, you may notice a slight smell or fumes due to dust or dirt. Especially if it has not been used for some time

- This appliance may be used by children from 8 years old and by persons with disabilities or with a lack of experience if they are supervised or have been instructed in the safe use of the appliance and understand the resulting risks. Children must not play with the appliance.
- The exhaust double duct must be checked regularly for damage and to ensure that it is not loose, especially after long journeys; this also applies to the mounting of the appliance and the cowl.

### **Operation while the vehicle is in motion**

- For heating while the vehicle is in motion, a safety shut-off device is specified in the guideline UN ECE R 122 for Motorcaravans and Caravans. The Truma MonoControl CS gas pressure regulation system fulfils this requirement. If this gas pressure regulation system is installed with the corresponding dimensioned gas installation, operation of a type-tested liquid gas heater while the vehicle is in motion is permitted throughout Europe according to UN ECE R 122. National rules and regulations must be observed.
- If **no** safety shut-off device is installed (e.g. as contained in the Truma MonoControl CS gas pressure regulation system), the gas cylinder must remain closed while the vehicle is moving and **signs** must be attached in the cylinder compartment and near the control panel.
- LP gas appliances must not be used while the vehicle is being refuelled, in covered car parks, garages or on ferries.

### **What to do in case of malfunctions**

- If you notice unusual noises or smells, close the gas supply and switch off the appliance.
- Risk of fire / explosion if you attempt to use an appliance that has been damaged by flooding or if the vehicle has been involved in an accident. Damaged appliances must be professionally repaired or replaced.
- Have malfunctions rectified by an expert without delay.
- Repair malfunctions yourself only if the repair is described in the troubleshooting guide of these operating instructions.

- After deflagration (misfiring), have the appliance and the exhaust duct checked professionally.

### **Maintenance / repair / cleaning**

- The appliance may only be repaired, maintained and cleaned by a qualified service technician.
- A new O-ring must always be installed after dismantling the exhaust duct!
- Children must not carry out maintenance, repair or cleaning work.
- The following will especially void warranty, guarantee and liability claims:
  - Modifications to the appliance (including accessories),
  - Modifications to the exhaust duct or cowl,
  - Use of spare parts and accessories other than Truma original parts,
  - Non-compliance with installation and operating instructions.

The operating permit for the appliance is also void and, as a result, also the vehicle operation permit in some countries.

- To prevent damage from spray water, such as when cleaning the vehicle, do not spray water directly into the cowl.

## Function description

VarioHeat is a warm-air heater for circulated air operation to heat camping vehicles quickly. The burner is fan-assisted, which ensures that operation is problem-free, even when on the move.

The appliance automatically chooses the required operating level based on the temperature difference between the temperature set on the control panel and the current room temperature. It also has a boost function for rapid heating and a night function for quieter operation. The different ventilation levels allow circulation mode without heating.

The digital control panel allows other functions to be selected, such as a time switch or operation of a Truma air conditioning system. Information can be found in Truma CP plus VarioHeat digital control panel

The appliance always starts at the lowest setting. If this is not sufficient to reach the desired temperature in the vehicle, after about 5 minutes the appliance switches to a higher operating level.

## Operating instructions

**Before starting the appliance for the first time, it is important that you read the operating instructions and "Important operating notes".** The vehicle owner is responsible for ensuring that the appliance can be operated as intended.

The installer or vehicle owner must attach the yellow sticker with the warning that is supplied with the device at a place in the vehicle that is visible for every user (e.g. on the wardrobe door). More stickers can be obtained from Truma.

### Start-up

- Remove the cowl cover.
- Open the gas cylinder and quick-acting valve in the gas supply line.
- Switch on the heater, see **Truma CP plus VarioHeat digital control panel**

If the appliance will not be used for some time, replace the cowl cover and close the quick-acting valve in the gas supply line and the gas cylinder.

### Room temperature sensor

An external room temperature sensor is installed in the vehicle to measure the room temperature. The vehicle manufacturer determines the position of the sensor individually depending on the type of vehicle. For more details, please refer to your vehicle operating manual.

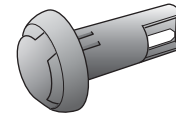

**Fig. 1**

The temperature setting on the control panel depends on your personal warmth requirements and the design of the vehicle and must be determined individually.

### Digital control panel Truma CP plus VarioHeat

#### Intended use

The Truma CP plus VarioHeat control panel is used to control and monitor a Truma VarioHeat heater and / or a Truma air conditioning system.

The following air conditioning systems can be operated<sup>1</sup> with the Truma CP plus VarioHeat:

- Aventa comfort<sup>2</sup>
- Saphir comfort RC

The Truma CP plus VarioHeat is intended for installation in caravans and motorcaravans.

<sup>1</sup> or Truma CP plus VarioHeat CI-BUS for CI-BUS – cannot be retrofitted.

<sup>2</sup> From serial number 24084022 – 04/2013.

## Safety instructions

- Use the Truma CP plus VarioHeat control panel only when it is technically intact.
- Have malfunctions repaired without delay. Repair malfunctions yourself only if the repair is described in the troubleshooting guide of these operating instructions.
- Do not repair or modify the Truma CP plus VarioHeat control panel.
- Have defective Truma CP plus VarioHeat control panels repaired only by the manufacturer or its service department.
- Never use LP gas appliances while the vehicle is being refuelled, in covered car parks, garages or on ferries. Switch the LP gas appliance off on the Truma CP plus VarioHeat control panel.

## Important information

- If the power supply for the system is interrupted, you must reset the time / time switch.
- If a new / replaced appliance (heater, air conditioning system) is connected to the bus system, you must repeat the procedure described in "Initial start-up".

### Air conditioning systems – joint use of IR remote control and Truma CP plus VarioHeat control panel

- When the Truma CP plus VarioHeat control panel has been connected, you can still use the IR remote control to operate the air conditioning system. The Truma CP plus VarioHeat control panel recognises all settings that were made on the air conditioning system with the IR remote control. The IR remote control transmits only the settings shown in its display (no bidirectional communication).
- To define the start and end times of a required period, use only the time switch of the Truma CP plus VarioHeat control panel.

## Display and operating elements

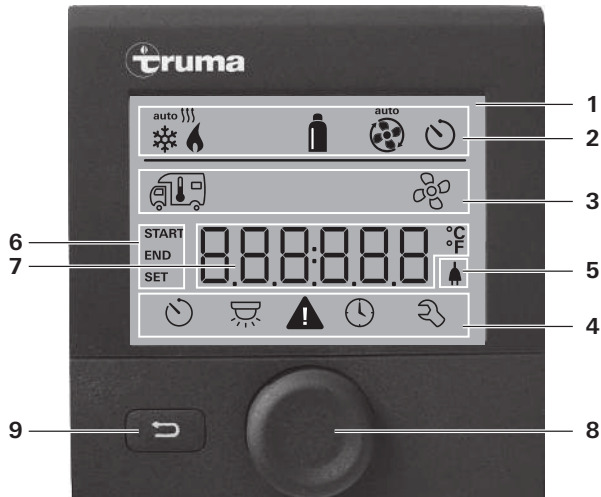

Fig. 2

- 1 = Display
- 2 = Status line
- 3 = Menu line (top)
- 4 = Menu line (bottom)
- 5 = Voltage display 230 V ~ (onshore power supply)
- 6 = Time switch display
- 7 = Settings / values
- 8 = Rotary push button
- 9 = Back button

Use the rotary push button (8) to select menus in the lines (3 + 4) and to make settings. The screen (1) has background lighting. Use the back button (9) to exit a menu.

## Rotary push button

The rotary push button (8) is used to select and change set-points and parameters and to store them by tapping. Selected menu items flash.

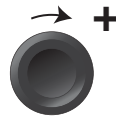

Fig. 3

- Turning in a clockwise direction**
- The menu is scrolled from left to right.
  - Increase values (+).

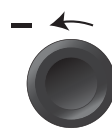

Fig. 4

- Turning in an anti-clockwise direction**
- The menu is scrolled from right to left.
  - Reduce values (-).



Fig. 5

- Tap**
- Apply (save) a selected value.
  - Select a menu item, go to the settings level.

- Press and hold**
- Main switching function ON / OFF

## Back button

Press the back button (9) to exit a menu and cancel settings. This means that the previous values remain.

## Initial start-up

For initial start-up of the system, carry out the following steps:

- Switch on the power supply.
  - 12 V = for the Truma CP plus VarioHeat control panel and Truma VarioHeat and 230 V ~ power supply for air conditioning systems.
- Start the appliance search under menu item Service menu → RESET → PR SET.

When you have confirmed, the Truma CP plus VarioHeat control panel is initialised. During this process, INIT ... is shown in the display. The appliances that are discovered are stored in the control panel.

## Start-up

Start / stand-by screen

When the Truma CP plus VarioHeat control panel has been connected to the power supply, a start screen is displayed after a few seconds.

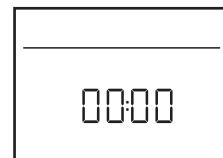

Fig. 6

- The display on the screen alternates between the time and the room temperature that was set.
- Special displays for commands via the IR remote control for the air conditioning system or CI-BUS (see "Special displays" on page 10).
- After a repair / retrofit, you have to repeat the initial start-up.



## Functions

The functions in the menu lines (3, 4) of the Truma CP plus VarioHeat control panel can be selected in any sequence. The operating parameters are shown in the status line (2) or the displays (5, 6).

### Selecting the settings level

- Tap the rotary push button.

The display shows the settings level. The first icon flashes.

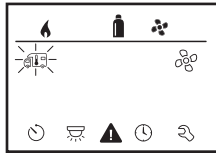

Fig. 7

### Switching on and off

#### Switching on

- Tap the rotary push button.

**i** – The previously set values / operating parameters are active again after you switch on.

#### Switching off

- Press the rotary push button for longer than 4 seconds.

**i** Because of internal time lags from the heater or air conditioning system, the switching off process of the Truma CP plus VarioHeat control panel may be delayed by a few minutes (during this time, OFF is shown in the display).



### Changing the room temperature

- With the rotary push button, select the icon in the menu line (3).
- Tap to go to the settings level.
- Depending on what appliances are connected, use the rotary push button to select heater (HEATER) or air conditioning system (AC).
- Tap the rotary push button to confirm your selection.
- Use the rotary push button to select the desired temperature.
- Tap the rotary push button to confirm the value.

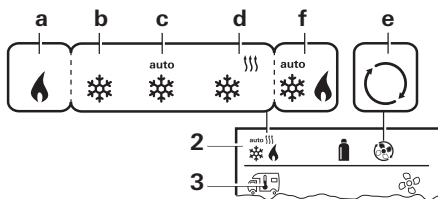

Fig. 8

#### Heater (HEATER)

Adjustable temperature range 5 – 30 °C (1 °C increments)

a = Heater on – icon is lit

The icon flashes until the set room temperature is reached.

#### Air conditioning system (AC)

Adjustable temperature range 16 – 31 °C (1 °C increments)

- b = COOL – Air conditioning system is switched on
- c = AUTO – Air conditioning system is set to automatic
- d = HOT – Air conditioning system is in heating mode
- e = VENT – Air conditioning system is in circulation mode

**i** Rapid temperature changes can be made with the rotary push button (in the stand-by screen).



### Selecting the fan speed

With connected heater / air conditioning system

- With the rotary push button, select the icon in the menu line (3).
- Tap to go to the settings level.
- Use the rotary push button to select the desired fan speed.
- Tap the rotary push button to confirm the value.

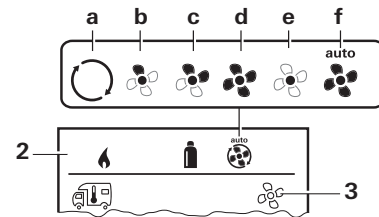

Fig. 9

#### Heater (HEATER)

Symbol	Operating mode	Description
–	OFF	Fan is switched off. (Can be selected only when no appliance is operating).
a	VENT <sup>1</sup>	Circulation when no appliance is operating. 10 speeds can be selected.
b	ECO	Automatic control of the fan depending on the heating output... / optimised to the current heating requirements
d	BOOST <sup>2</sup>	Rapid room heating Available if the difference between the selected and current room temperature is >10 °C.
e	NIGHT	Especially quiet fan operation suitable for night-time use, for example

<sup>1</sup>. Can cause increased motor wear, depending on how often it is used.

<sup>2</sup>. Fan level BOOST consumes more electricity, is louder and increases motor wear.

**i** When the heater is switched on (room temperature set), the status line (2) shows the fan speed that was selected in the previous heating process. The default setting is ECO.

#### Air conditioning system (AC)

Symbol	Operating mode	Description
–	OFF	Fan is switched off (Can be selected only when no appliance is operating).
a	–	–
b	LOW	Low fan speed
c	MID	Middle fan speed
d	HIGH	Highest fan speed
e	NIGHT	Especially quiet fan operation
f	AUTO	Automatic selection of fan speed. Cannot be changed in AUTO mode.



## Adjusting the time switch



### Risk of poisoning from exhaust gases.

The activated time switch switches the heater on even if the RV is parked. The exhaust gases from the heater can cause poisoning in enclosed spaces, such as garages or repair shops.

If the RV is parked in an enclosed space:

- Block the fuel feed (gas) to the heater.
- Deactivate the time switch of the Truma CP plus VarioHeat control panel (OFF).
- Switch off the heater on the Truma CP plus VarioHeat control panel.



- If air conditioning systems are operated, use only the time switch of the Truma CP plus VarioHeat control panel to set the start and end times of a desired period.
- If the time switch is activated (ON), the Deactivate time switch menu (OFF) is shown first.
- With the rotary push button, select the icon in the menu line (4).
- Tap to go to the settings level.

### Enter the start time

- Use the rotary push button to set the hours and then the minutes.

24 h mode

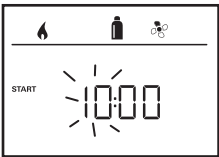
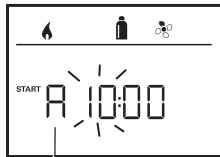

Fig. 10

12 h mode



A = a. m.  
P = p. m.

Fig. 11

### Entering the end time

- Use the rotary push button to set the hours and then the minutes.

24 h mode



Fig. 12

12 h mode

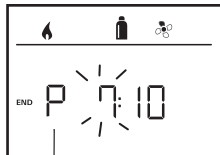

A = a. m.  
P = p. m.

Fig. 13

- If the start/end time has already passed when you make the entries, the operating parameters are considered only when the next start/end times are reached. Until then, the operating parameters set outside the time switch remain valid.

### Adjusting the room temperature

- Depending on what appliances are connected, use the rotary push button to select heater or air conditioning system.
- Tap the rotary push button to confirm your selection.
- Use the rotary push button to select the desired room temperature.
- Tap the rotary push button to confirm the value.

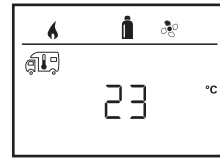

Fig. 14

### Selecting the fan speed

- Use the rotary push button to select the desired fan speed.
- Tap the rotary push button to confirm the value.

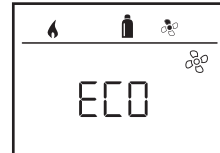

Fig. 15

### Activating the time switch (ON)

- Use the rotary push button to activate the time switch (ON)
- Tap the rotary push button to confirm the value.

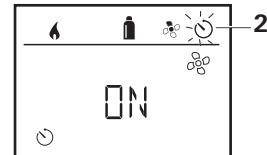

Fig. 16



- The time switch remains active, also for several days, until it is deactivated (OFF).
- If the time switch is programmed and active, the time switch icon flashes.

### Deactivating the time switch (OFF)

- Tap to go to the settings level.
- Use the rotary push button to deactivate the time switch (OFF)
- Tap the rotary push button to confirm the value.



Fig. 17





## Switching the lighting on and off

Available if an

Aventa comfort or  
Aventa eco air conditioning system system is connected.

- With the rotary push button, select the icon in the menu line (4).
- Tap to go to the settings level.
- Use the rotary push button to select the desired function.

1 – 5 – Switch on the lighting.  
5 lighting levels can be selected.

OFF – Switch off the lighting.

- Tap the rotary push button to confirm the value.

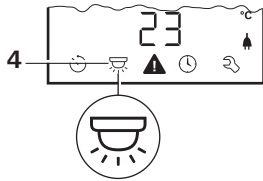

Fig. 18



## Setting the time

24 h mode display

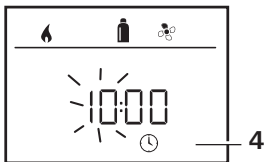

Fig. 19

12 h mode display



A = a. m.  
P = p. m.

Fig. 20

- With the rotary push button, select the "Setting the time" icon in the menu line (4).

The hour display flashes.

- Use the rotary push button (8) to set the hours.
- Tap the rotary push button (8) again and the minute display flashes.
- Use the rotary push button (8) to set the minutes.
- Tap the rotary push button (8) to confirm the value.



## Service menu

### 1. Calibrate the room temperature sensor of the heater (OFFSET)

The room temperature sensor of the connected heater can be adjusted individually to suit the installation location of the sensor. Settings are possible in 0.5 °C increments in a range from 5 °C to -5 °C.



Fig. 21

Example:  
Set room temperature 23 °C;  
OFFSET = -1 °C;  
- Setpoint for heater = 22 °C

Default setting: 0 °C (Celsius).

### 2. °C / °F Temperature display

Select temperature display °C (Celsius) or °F (Fahrenheit).

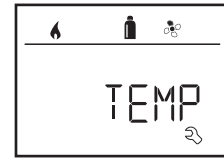

Fig. 22

Default setting: °C (Celsius).

### 3. Change the background lighting

The background lighting of the Truma CP plus VarioHeat control panel can be changed in 10 levels.



Fig. 23

### 4. 12 h / 24 h mode

Display the time in 12 h (a. m., p. m.) / 24 h mode.



Fig. 24

Default setting: 24 h mode

### 5. Change the language

Select the desired language (German, English, French, Italian).



Fig. 25

Default setting: English

### 6. Show version number

Show the version number of the heater, air conditioning system, Truma CP plus VarioHeat control panel.



Fig. 26

Example:  
H 1.20.01 → H = Appliance; 1.20.01 = Version number

#### Appliance

P = Truma CP plus VarioHeat control panel  
A = Air conditioning system  
H = Heater

### 7. Default setting (RESET)

The reset function resets the Truma CP plus VarioHeat control panel to the factory settings. All settings are deleted. Newly connected appliances are recognised and stored in the control panel.

- Switch on the power supply  
12 V = for the Truma CP plus VarioHeat control panel and Truma VarioHeat and  
230 V ~ power supply for air conditioning systems.

## Reset

- Use the rotary push button (8) to select RESET.
- Tap the rotary push button (8).
- PR SET is displayed on the screen.
- Tap the rotary push button (8) to confirm.

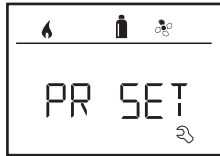

Fig. 27

When you have confirmed, the Truma CP plus VarioHeat control panel is initialised.

During this process, INIT ... is shown in the display.

## Special displays

### Power supply 230 V / 240 V ~ available

This icon shows that a 230 V / 240 V ~ power supply (onshore power supply) is available.

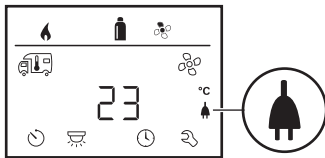

Fig. 28

- The icon is displayed only in combination with a Truma air conditioning system.

### Infrared (IR) remote control (air conditioning system)

If a command is sent via the infrared remote control of the air conditioning system, IR is displayed on the screen.

### External control panel (CI-BUS)

If a command is sent via the external control panel with CI-BUS, CI is displayed on the screen.

- The Truma CP plus VarioHeat control panel CI-BUS is a separate variant that is fitted only in the factory.

### Energy type display

- In heating mode, the energy type gas (a) is displayed

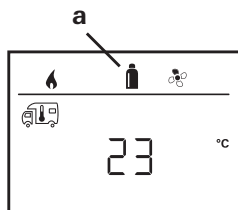

Fig. 29

## Warning

This icon shows that an operating parameter has reached an undefined status. In this case, the appliance concerned continues to operate. When the operating parameter returns to the target range, the icon disappears automatically.

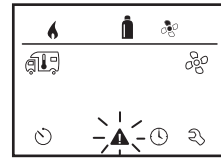
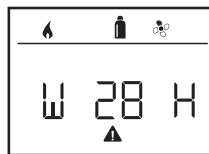

Fig. 30

### Read the warning code

- Select the icon with the rotary push button.
  - Tap the rotary push button.
- The current warning code is shown. With the help of the troubleshooting guide (from page 13 et seq.) you can find the cause of the warning and rectify it.



W = Warning  
28 = Error code  
H = Appliance  
H = Heater  
A = Air conditioning system

Fig. 31

### Cause rectified / return to settings level

- Tap the rotary push button.

### Cause not rectified / return to settings level

- Press the back button.

- In this case, the warning on the Truma CP plus VarioHeat control panel is not acknowledged and the warning icon remains. The appliance concerned remains in warning status. Other connected appliances can still be operated.

## Error

In case of an error, the Truma CP plus VarioHeat control panel immediately goes to the menu level "Error" and shows the error code. With the help of the troubleshooting guide (from page 13 et seq.) you can find the cause of the error and rectify it.

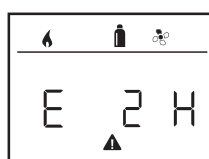

E = Error  
2 = Error code  
H = Appliance  
H = Heater  
A = Air conditioning system

Fig. 32

### Cause rectified / return to settings level

- Tap the rotary push button.
- The corresponding appliance is restarted.

- This may take a few minutes due to internal time lags of the connected appliances.

If the cause was not rectified, the error will reoccur and the control panel will again go to the menu level "Error".

### Cause not rectified / return to settings level

- Press the back button.

- In this case, the error on the Truma CP plus VarioHeat control panel is not acknowledged and the warning icon remains. The appliance remains in error status. Other connected appliances can still be operated.

## Display specifications

<b>Display</b>	LCD, monochrome, with background lighting
<b>Dimensions (L x W x H)</b>	92 x 103 x 40 mm
<b>Operating temperature range</b>	-25 °C to +60 °C
<b>Storage temperature range</b>	-25 °C to +70 °C
<b>Interfaces</b>	
<b>Truma CP plus VarioHeat Truma</b>	TIN Bus
<b>CP plus VarioHeat CI-BUS</b>	TIN Bus, CI-BUS
<b>Power supply</b>	8 V – 16.5 V =
<b>Power consumption at nominal voltage 12 V =</b>	max. 65 mA (100% background lighting) 6.5 mA – 10 mA (stand-by)
<b>Quiescent current consumption</b>	max. 3 mA (off)
<b>Weight</b>	approx. 100 g



Technical changes reserved.

## Maintenance of the Display

The Truma CP plus VarioHeat control panel requires no maintenance. To clean the front use a non-abrasive, moist cloth. If this is not sufficient, use a neutral soap solution.

## VarioHeat fuses

The fuse is located on the electronic control unit in the appliance and can be replaced only by a professional.

Appliance fuse (F1):  
10 AF – quick-acting – (EN 60127-2-3)

The micro fuse must be replaced by a similar fuse.

## Disposal of the VarioHeat

The appliance must be disposed of in accordance with the waste laws in the country in which it is used.

## Maintenance of the VarioHeat

The VarioHeat requires no maintenance. Truma recommends that the VarioHeat be inspected annually by a qualified service technician.

## Heater specifications

<b>Type of gas</b>	Propane
<b>Test point pressure</b>	2.00 kPa (see type plate)
<b>Operating pressure</b>	2.75 kPa (see type plate)
<b>Rated thermal input (gas consumption)</b>	
Min. stage:	4.53 MJ/h (90 g/h) ISA
Max. stage:	9.75 MJ/h (193 g/h) ISA
<b>Thermal efficiency</b>	
Min. stage:	86.4%
Max. stage:	84.3%
<b>Air flow rate</b>	85 m <sup>3</sup> /h - 175 m <sup>3</sup> /h
<b>Duct static pressure</b>	< 170 Pa (1.7 mbar)
<b>Temperature rise</b>	< 80 °C
<b>Power supply</b>	10.5 - 16 V =
<b>Power consumption at nominal Voltage 12 V =</b>	
Operating:	0.85 - 3.65 A
Stand-by:	0.004 A
<b>Weight</b>	
Heater without periphery:	5.5 kg

Subject to technical changes.

Dimensions (all dimensions are in mm)

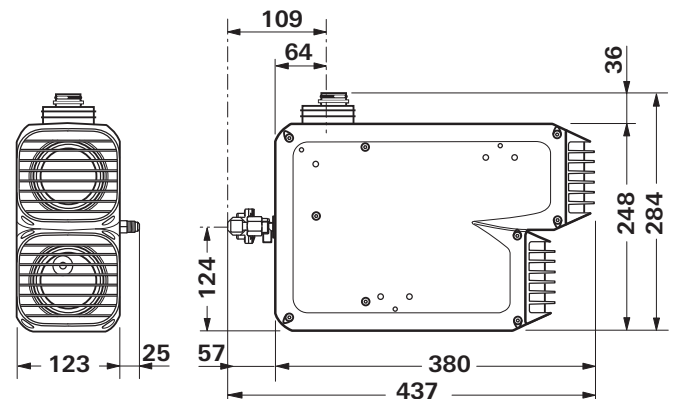

Fig. 33

## Truma warranty policy

The warranty is given by Dometic Pty Ltd, Building 3B, Clayton Business Park, 1508 Centre Road, Clayton, Victoria, 3168, for 12 months from the date of purchase against any defect arising from faulty materials or workmanship.

Repairs will be carried out during normal business hours only by Dometic Pty Ltd, or its duly authorised service agents, and are subject to the warranty conditions and exclusions hereunder.

### Warranty conditions

- The company will only provide service on presentation of proof of purchase, on either the Truma product, or the Caravan / RV / Pleasure Craft in which the Truma product has been installed, to any authorised service agent. The purchaser must allow the service agent to photocopy the proof of purchase to facilitate his claim to the manufacturer.
- Warranty repairs can only be performed by authorised service agents and under no circumstances will Dometic reimburse repairs carried out by unauthorised persons. Tampering with any part of the product by unauthorised personnel will automatically void the warranty.
- The product must be used solely for domestic purposes. If the product is used for commercial purposes, the warranty is 6 months only.
- Where applicable, the products must be used with the appropriate electrical voltage, gas type and pressure, or fuel source.
- If at any time during the warranty period any part or parts are replaced with a part or parts not supplied or approved by Truma, this warranty shall immediately become void.

### Important notice

Before calling a service technician please check carefully the operating instructions, warranty terms and conditions. If the product fails for any of the reasons detailed therein, or is faulty due to abuse, misuse or improper installation, then a service fee shall be charged to the purchaser.

If you have any queries regarding the interpretation of the warranty you should contact Dometic Pty Ltd.

Whilst this book represents service outlets at the time of printing, changes occur from time to time. Should you have any queries or wish to locate your nearest authorised service agent please contact Dometic Pty Ltd.

### Warranty does not cover

- Any heater which has been:
  - (a) Subject to misuse, neglect, accident or alteration by any person.
  - (b) Damaged or destroyed by fire, flood, act of God or other inevitable accident.
- Fair wear and tear.
- Damage from foreign substances such as dirt or liquid.
- Travelling expenses or call out fee to and from authorised service agents' premises.
- Accommodation or Site Expenses.
- Cleaning of the system or cleaning and adjustment of the gas system. This is considered to be a part of normal product maintenance.
- Non operation of the heater or resultant damage to the unit where the heater has been operated in an out of level situation.
- Freight cost of the appliance or parts, to or from, point of service or transit damage.
- Dometic / Truma are not responsible for resultant loss or damage sustained by the purchaser.
- Non operation of the appliance or resultant damage to the unit where the appliance has not been installed, ventilated, flued or operated in accordance with the manufacturer's instructions.

Apart from any warranties implied by the Trade Practices Act 1974 or any relevant State legislation all other warranties express or implied whether arising by virtue of statute or otherwise are hereby excluded.

## Troubleshooting guide for Truma VarioHeat

Error	Cause	Rectification
# 2	Flame not detected:	
# 16	<ul style="list-style-type: none"> <li>– Gas cylinder or quick-acting valve in the gas supply line closed</li> <li>– Gas pressure regulation system iced up</li> <li>– Butane content in the gas cylinder too high</li> <li>– Combustion air infeed or exhaust gas outlet closed</li> </ul>	<ul style="list-style-type: none"> <li>– Check gas supply and open valves</li> <li>– Use EisEx controller heater</li> <li>– Use propane (butane is not suitable for heating especially at temperatures below 10 °C )</li> <li>– Check if openings are blocked (slush, ice, leaves, etc.) and clear if necessary</li> </ul>
# 25	– Overvoltage > 16.4 V $\approx$	– Check battery voltage and voltage sources, such as charger
# 26	– Undervoltage battery voltage too low < 10 V $\approx$	– Charge battery, if necessary, replace old battery
# 27	<ul style="list-style-type: none"> <li>– Warm air outlets blocked</li> <li>– Circulated air intake blocked</li> </ul>	<ul style="list-style-type: none"> <li>– Remove blockage</li> <li>– Remove blockage</li> </ul>
# 28	– Window above cowl open (window switch)	– Close window
# 29	– Imminent undervoltage, battery voltage too low < 10.4 V $\approx$	– Charge battery

**If these measures do not rectify the error, please contact the nearest Dometic Service Centre.**

## Troubleshooting guide (air conditioning system)

Error code	Cause	Rectification
# 2	Breakdown ice sensor – inside	Check filter and replace if necessary
# 4	Breakdown ice sensor – outside (if fitted)	Keep air inlets / outlets on the roof free of obstructions such as leaves

**If these measures do not rectify the error, please contact the nearest Dometic Service Centre.**







**AUS** In Australia, always notify the Dometic Service Centre if problems are encountered; in other countries the relevant service partners should be contacted ([www.truma.com](http://www.truma.com)).

Having the equipment model and the serial number ready (see type plate) will speed up processing.