



COAX wiring Options for different set top box combinations

900-06100

GOG ANT/SAT DIPLEXER. AS2



900-06102

GOG MULTISWITCH 3 IN 4 OUT. SW34



900-06002

SPHERE TWIN LNB SATELLITE SYSTEM. SSA-850



Please read the User Manual in its entirety before installing or operating any product.

Disclaimer:

Coast RV PTY LTD accepts no liability for any loss or damage, which may occur as a result of improper or unsafe use of its products. Warranty is only valid if the product has not been modified or misused and the original proof of purpose can be provided.

Connection diagram

2x Single Tuner Set top box example.

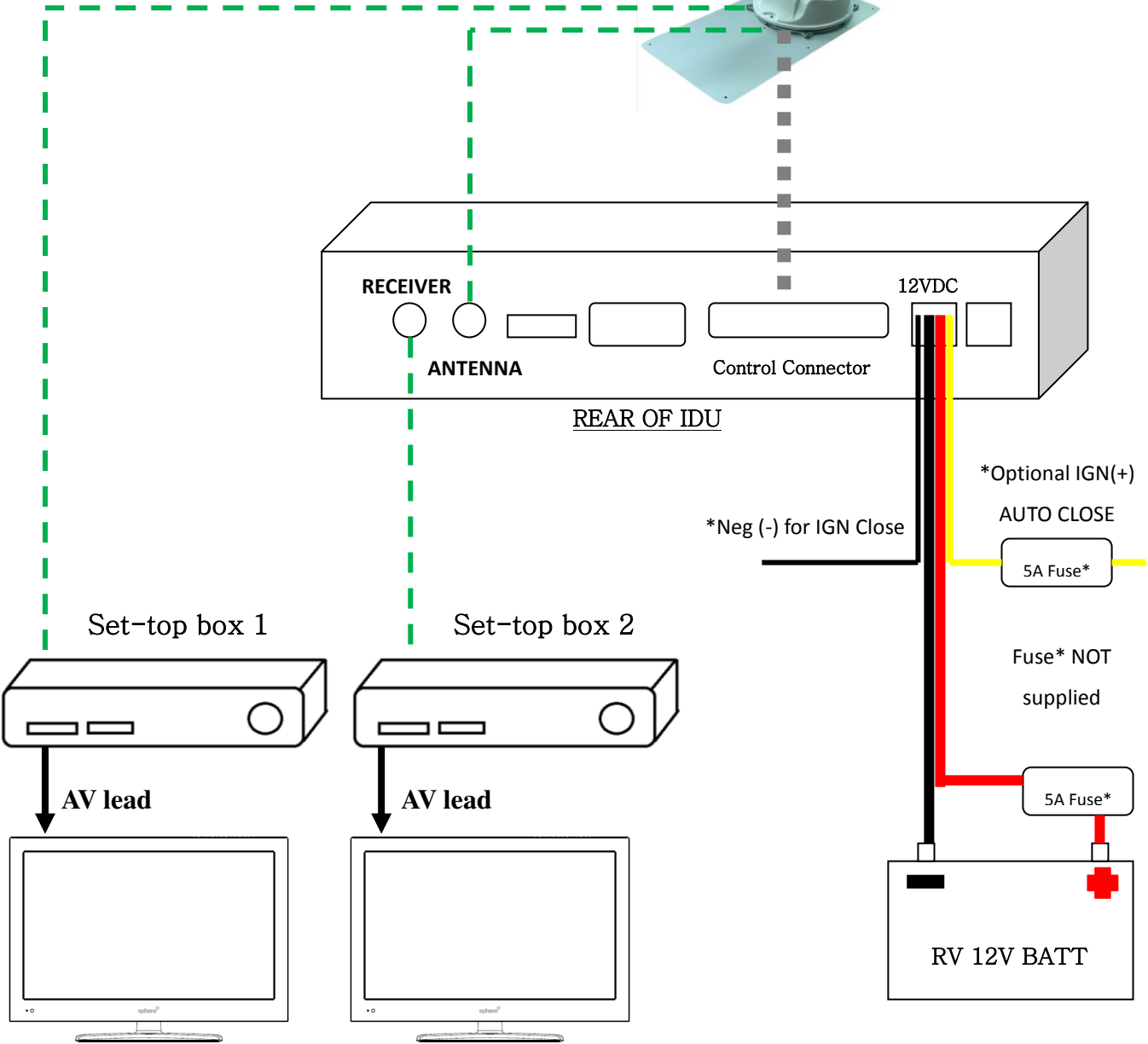

Connection diagram

1x Twin Tuner Set top box example.

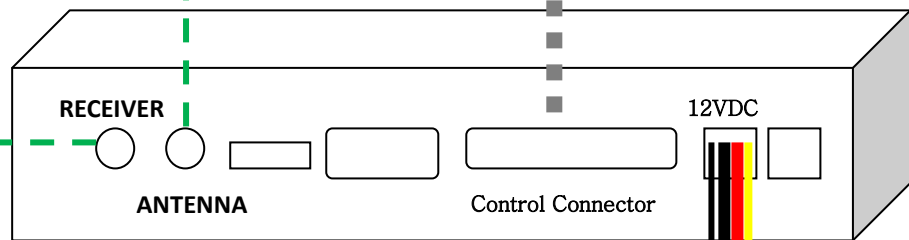

REAR OF IDU

Set-top box 1
This is a *TWIN TUNER* box that requires 2x LNB Coax feeds.

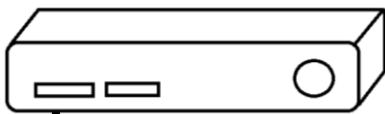

AV lead

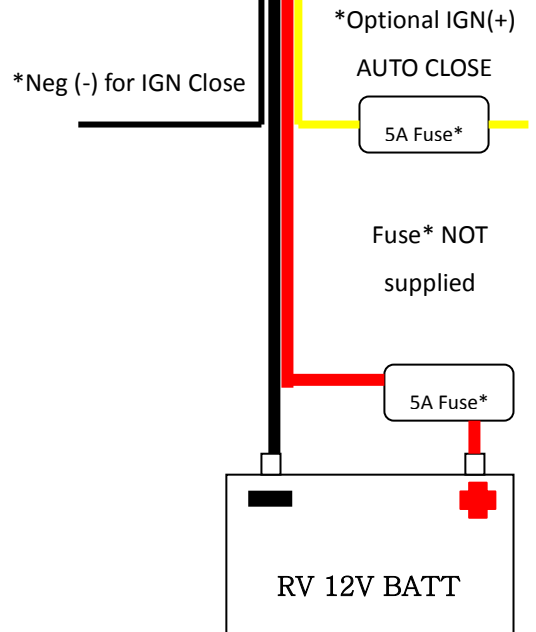
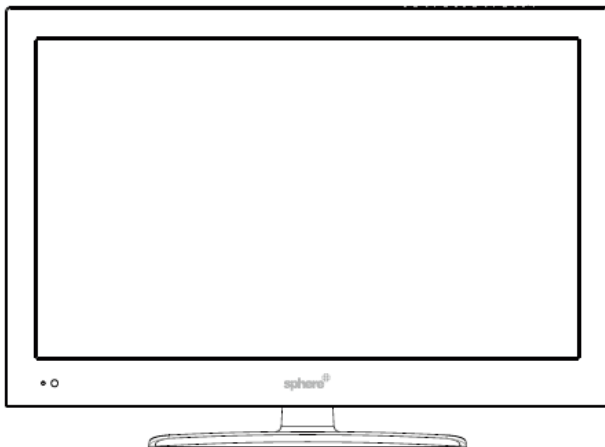

Connection diagram

1x Single Tuner & 1x TWIN TUNER

With the use of a 'MultiSwitch' to feed the set top boxes.

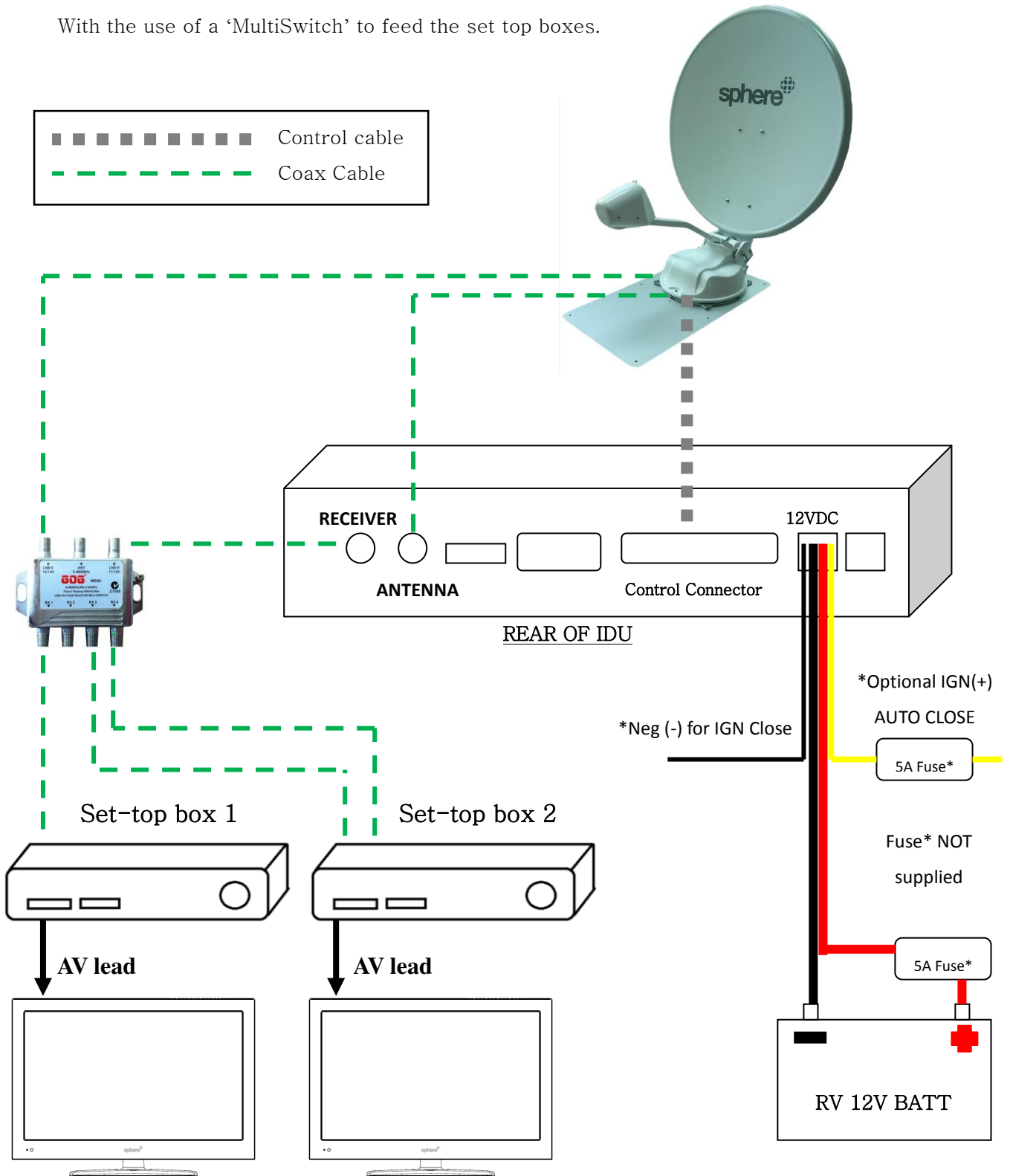

Connection diagram

2x TWIN TUNER

With the use of a 'MultiSwitch' to feed the set top boxes.

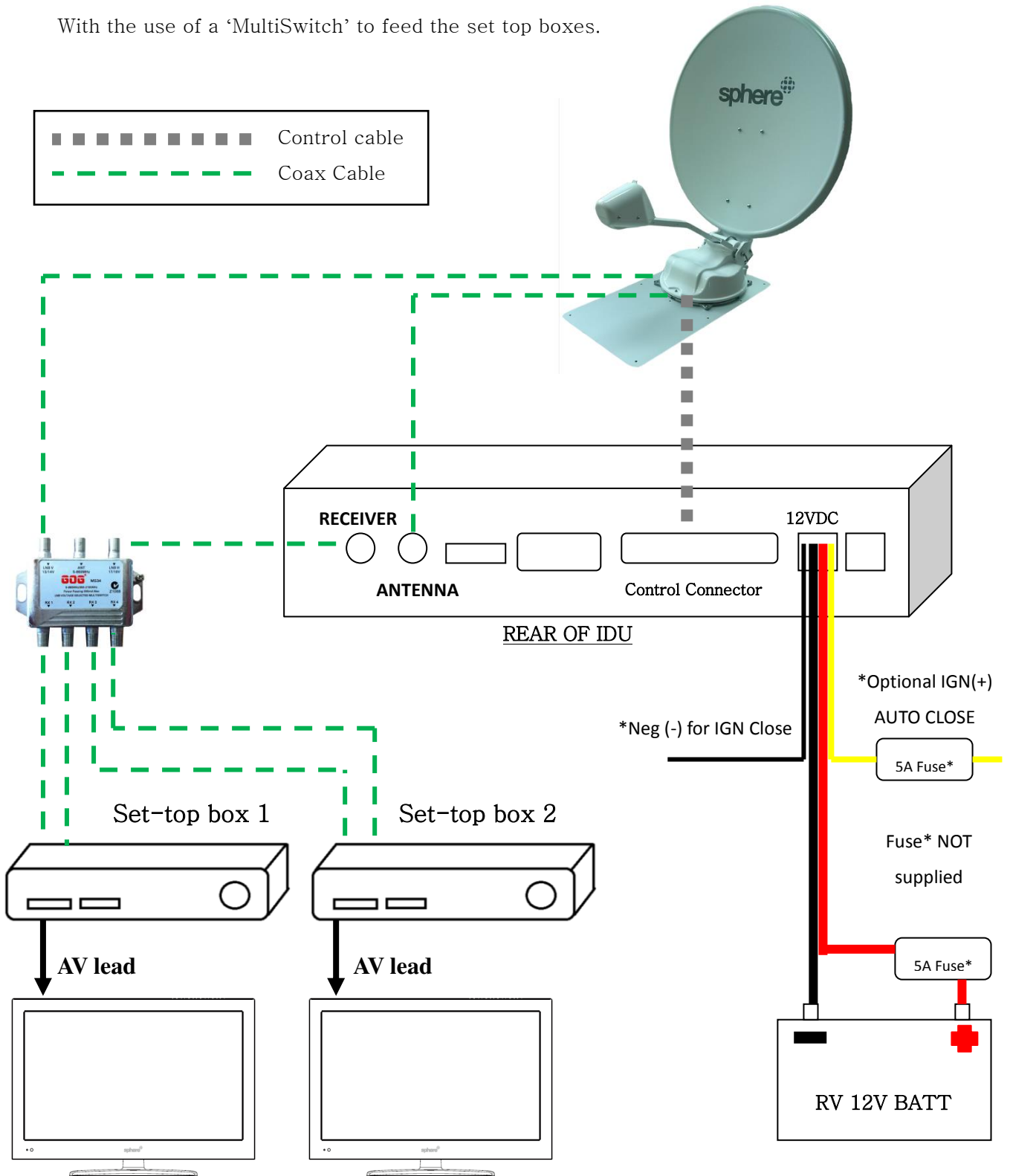

Connection diagram

1x Single Tuner & 1x TWIN TUNER

With the use of a 'MultiSwitch' and 'Diplexer' to feed the set top boxes and TV signal with a common/single coax feed.

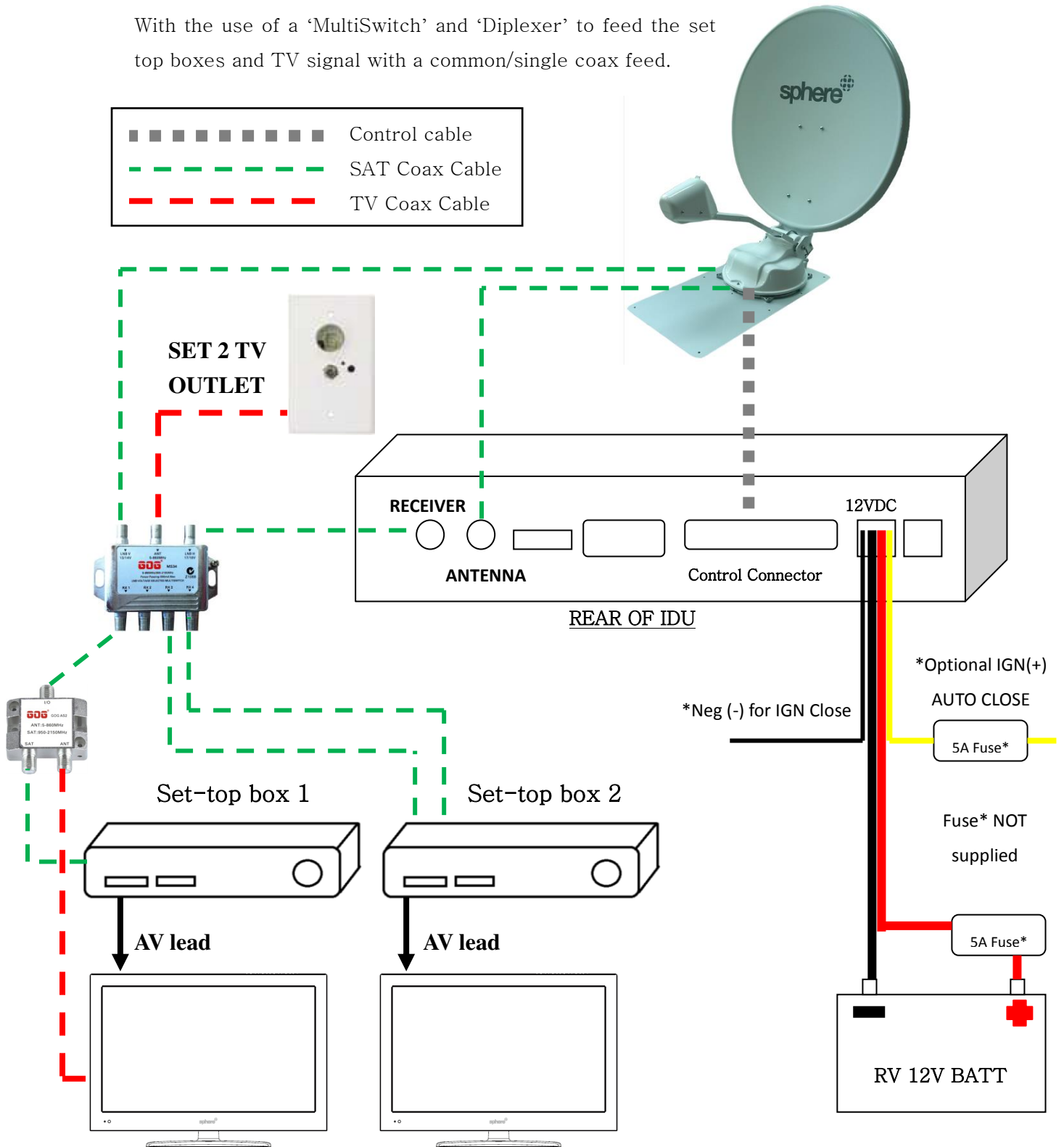

Connection diagram

'MultiSwitch' and 'Diplexer' Example

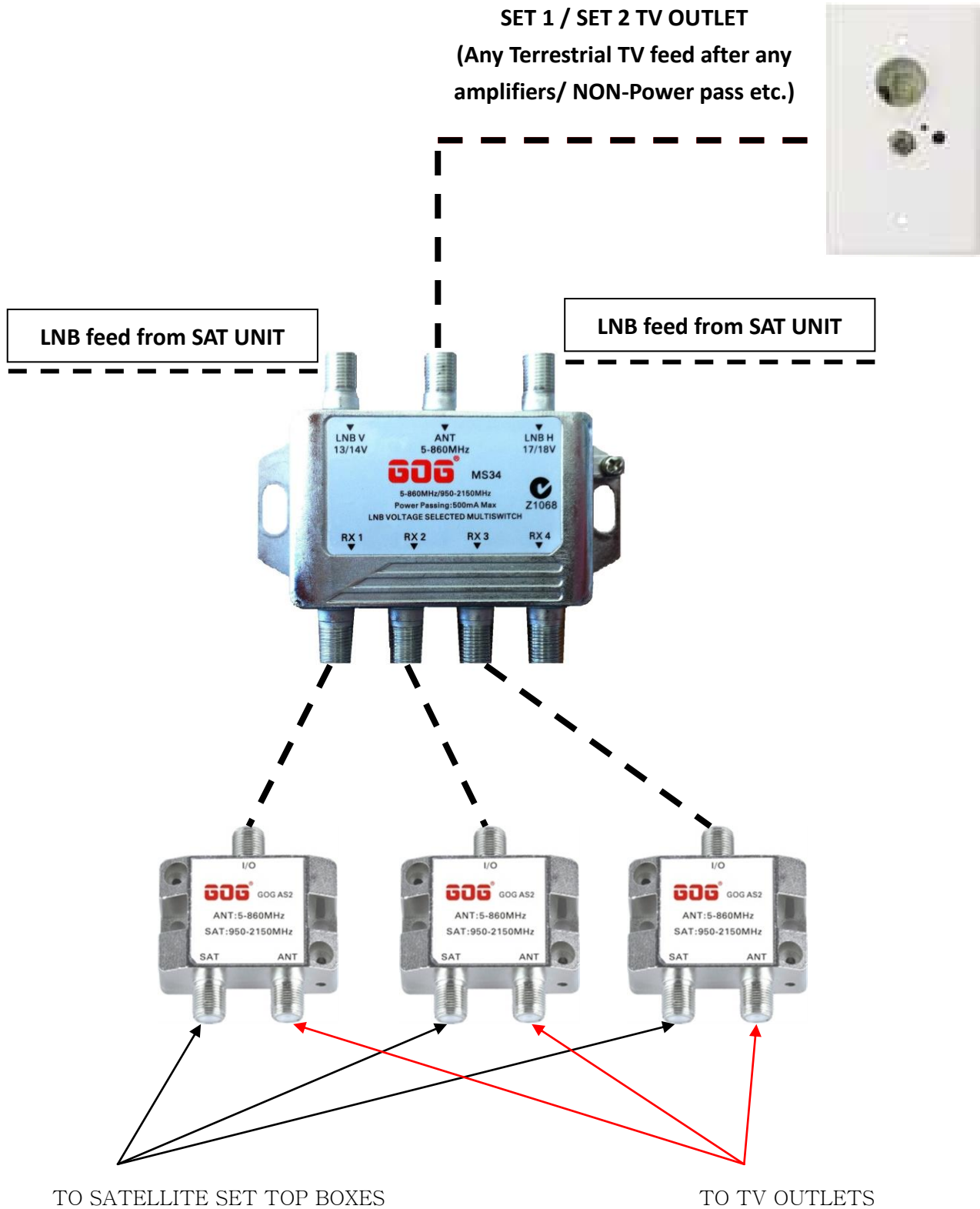

Connection diagram

2x 'Diplexer' Example to carry both SAT and TV signals down the common line

From TV Antenna feed

From Satellite LNB feed

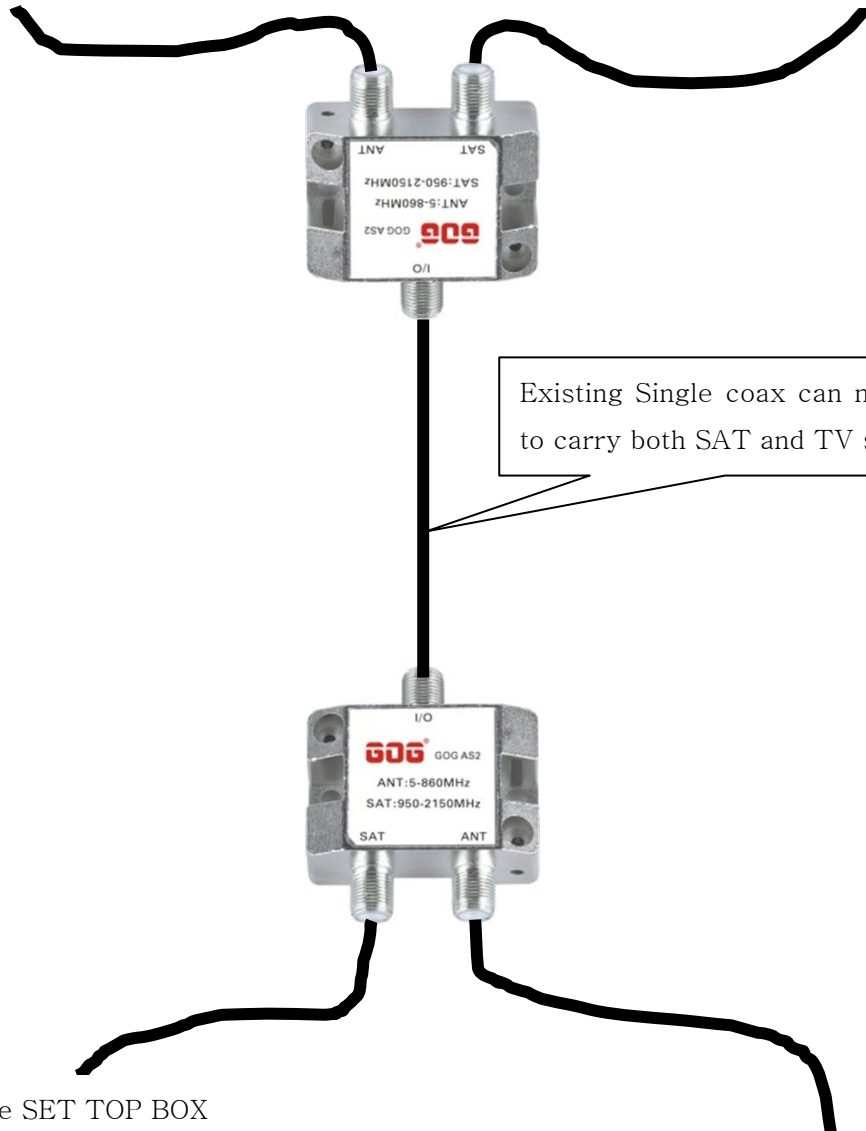

Existing Single coax can now be used to carry both SAT and TV signals.

To Satellite SET TOP BOX

To TV OUT LET